

Design Example Using STR6A124MV:

27.8 W (15 V, 1.85 A)

Isolated Flyback Converter

Precautions for High Voltage

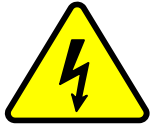

Dangerously high voltages exist inside the demonstration board.
Mishandling the demonstration board may cause the death or serious injury of a person.
Before using the demonstration board, read the following cautions carefully, and then use the demonstration board correctly.

DO NOT touch the demonstration board being energized.

Dangerously high voltages that can cause death or serious injury exist inside the demonstration board being energized.

Electrical shock may be caused even by accidental short-time contact or by putting hands close to the demonstration board.

Electrical shock can result in death or serious injury.
Before touching the demonstration board, make sure that the capacitors have been discharged.

For safety purpose, an operator familiar with electrical knowledge must handle the demonstration board.

The demonstration board is for evaluation of all the features of the STR6A124MV.
The demonstration board shall not be included or used in your mass-produced products.
Before using the demonstration board, see this document and refer to the STR6A124MV data sheet.
Be sure to use the demonstration board within the ranges of the ratings for input voltage, frequency, output voltage, and output current.
Be sure to strictly maintain the specified ambient environmental conditions, such as ambient temperature and humidity.

Contents

Precautions for High Voltage-----	2
1. Introduction -----	4
2. Power Supply Features-----	4
3. Applications -----	4
4. Design Example: Appearance-----	4
5. Design Example-----	5
5.1 Power Supply Specifications -----	5
5.2 Circuit Diagram -----	5
5.3 Bill of Materials-----	6
5.4 Pattern Layout Example-----	7
6. Design Example: Basic Operations -----	8
7. Designing the Power Supply -----	9
7.1 Setting an Output Voltage -----	9
7.2 Selecting the Bridge Rectifier Diode BR1 -----	9
7.3 Selecting the Clamp Snubber Circuit (D1, C3, R1, R5)-----	9
7.4 Selecting the VCC Pin Rectifier Diode D2-----	10
7.5 Selecting the Current-sensing Resistors (R3, R4) -----	10
7.6 Selecting the Secondary Rectifier Diode D51 -----	10
7.7 Transformer Specifications-----	11
8. Performance Data-----	13
8.1 Efficiency-----	13
8.2 Standby Power -----	14
8.3 Line Regulation -----	15
8.4 Load Regulation -----	15
9. Operation Check -----	16
9.1 Startup Operation-----	16
9.1.1 Power Supply IC Switching Operation -----	16
9.1.2 Output Voltage-----	17
9.1.3 VCC Pin Voltage -----	17
9.1.4 D51 and D2 Applied Voltages -----	18
9.2 Power Supply IC Switching Operation -----	19
9.2.1 Normal Operation-----	19
9.2.2 Light-load Operation (Green Mode, Burst Oscillation) -----	20
9.2.3 No-load Operation (Burst Oscillation) -----	21
9.3 Output Ripple Voltage -----	21
9.4 OCP and OLP Operations-----	22
9.5 OVP Operation -----	23
9.6 Case Temperature-----	23
10. Conducted Emission Test -----	24
Important Notes-----	26

1. Introduction

This document describes the design example of a power supply using the STR6A124MV intended for the isolated flyback converter that supports universal inputs and a 15 V/1.85 A output. The STR6A124MV is a current mode PWM control IC with a built-in power MOSFET. In addition, the design example uses the SARS05 as a diode for the resistor-capacitor-diode (RCD) snubber, the SJPX-H3 as a fast recovery diode for the IC's power supply, and the FMEN-220B as a Schottky diode for the secondary rectifier.

This document contains the following: the specifications of the design example, circuit diagrams, the bill of materials, the setting examples of component constants, a pattern layout example, and the evaluation results of the power supply characteristics. For more details on the parts listed in this document, refer to the corresponding data sheets.

2. Power Supply Features

- Improved Circuit Efficiency (Secondary Rectifier Diodes with Lower V_{RM} and V_F Characteristics Achieved by Step Drive Control Circuit)
- Adjustable Standby Operating Point
- Reduced Number of External Components (Built-in Startup Circuit)
- High Efficiency in All Load Ranges Achieved by Load-based Auto-shifting Operation Modes
 - Normal Operation: PWM Mode, 65 kHz (Typ.)
 - Light-load Operation: Green Mode
 - Standby Operation: Burst Oscillation Mode
- Efficiency: 90.0% (230 VAC, 27.8 W)
- Input Power at No Load: 41 mW (230 VAC)
- Reduced EMI Noise (Random Switching Function)

3. Applications

- Small Home Appliance
- Large Home Appliance
- Auxiliary Power Supply
- Power Supply for Motor Control
- Other SMPSs (Switching Mode Power Supplies)

4. Design Example: Appearance

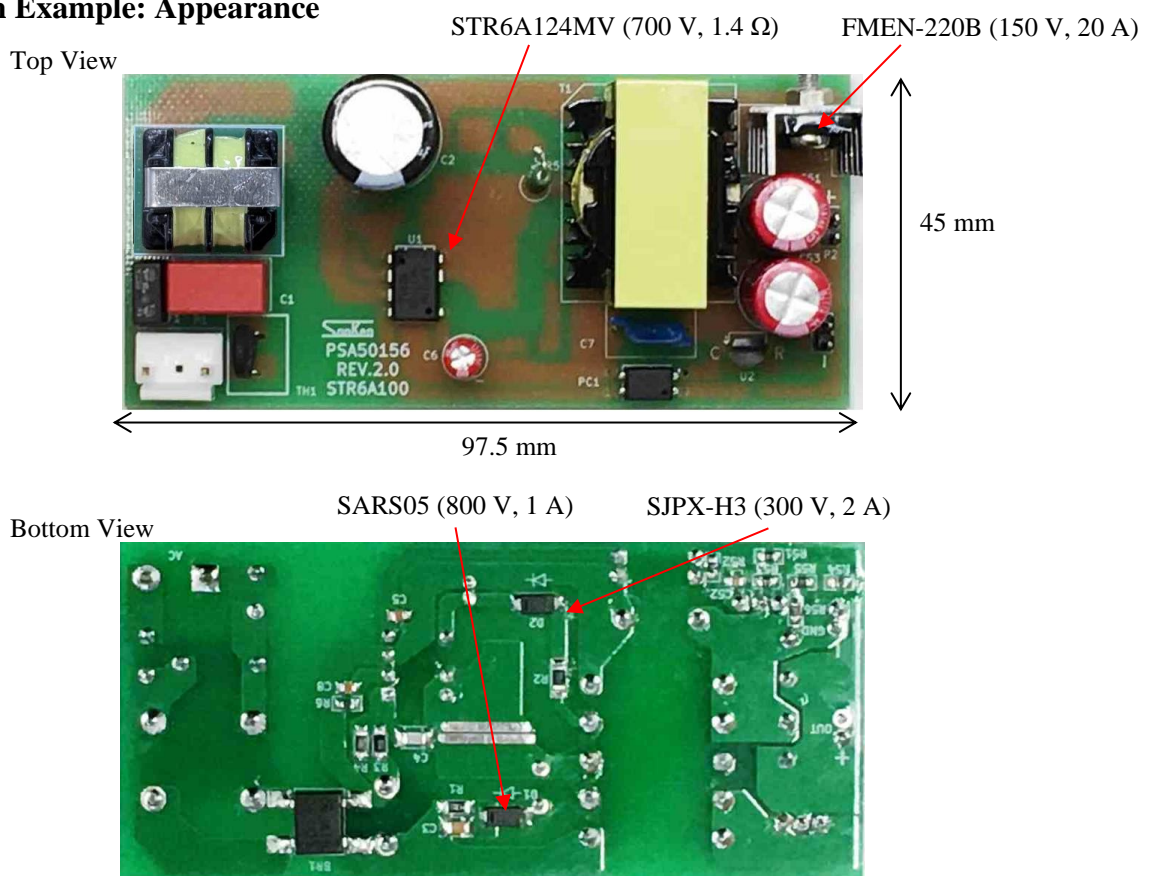

5. Design Example

5.1 Power Supply Specifications

Parameter	Symbol	Conditions	Min.	Typ.	Max.	Unit
Input						
Input Voltage	V_{INAC}		85	—	288	V
Frequency	f_{LINE}		47	50/60	63	Hz
Output						
Rated Voltage	V_{NP}		14.25	15	15.75	V
Rated Current	I_{NP}		—	1.85	—	A
Output Ripple Voltage	V_{RIPPLE}	20 MHz bandwidth; filter added ⁽¹⁾	—	350	—	mV _{P-P}
Output Power	P_{OUT}		—	27.8	—	W
Efficiency	η	Rated load, $T_A = 25^\circ\text{C}$, 230 VAC	—	90.0	—	%
Environment						
Conduction Noise	—	$T_A = 25^\circ\text{C}$	As per CISPR22B/EN55022B		—	—
Temperature						
Power Supply IC Temperature Increase ⁽²⁾	ΔT_{C-IC}	288 VAC, $I_O = 1.85\text{ A}$	—	46.1	—	$^\circ\text{C}$
Secondary Rectifier Diode Temperature Increase ⁽³⁾	ΔT_{C-DI}	288 VAC, $I_O = 1.85\text{ A}$	—	48.1	—	$^\circ\text{C}$
Transformer Temperature Increase	ΔT_L	288 VAC, $I_O = 1.85\text{ A}$	—	35.6	—	$^\circ\text{C}$

5.2 Circuit Diagram

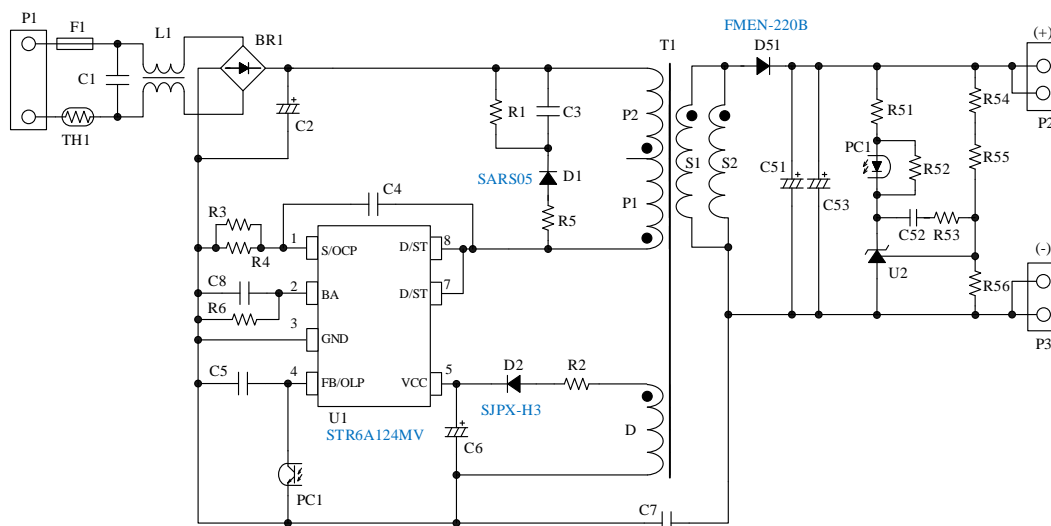

Figure 5-1. Circuit Diagram

⁽¹⁾ By connecting an electrolytic capacitor (50 V, 1 μF) and a ceramic capacitor (50 V, 0.1 μF) in parallel to the output connector of the PCB.

⁽²⁾ Refers to a case temperature of the STR6A124MV.

⁽³⁾ Refers to a case temperature of the FMEN-220B.

5.3 Bill of Materials

Part Symbol	Part Type	Ratings	Manufacturer / Part Number
F1	Hues	250 VAC, 2 A	
TH1	Power thermistor	4.7 Ω , 3 A	
C1	Film capacitor	310 VAC, 0.1 μ F	
C2	Electrolytic capacitor	450 V, 120 μ F	
C3	Chip ceramic capacitor	1000 V, 2200 pF	
C4	Chip ceramic capacitor	1000 V, 33 pF	
C5	Chip ceramic capacitor	50 V, 1500 pF	
C6	Electrolytic capacitor	50 V, 22 μ F	
C7	Ceramic capacitor	300 VAC, 2200 pF	
C8	Chip ceramic capacitor	50 V, 1000 pF	
C51	Electrolytic capacitor	25 V, 820 μ F	
C52	Chip ceramic capacitor	50 V, 0.22 μ F	
C53	Electrolytic capacitor	25 V, 820 μ F	
BR1	Bridge rectifier diode	800 V, 1.5 A	
D1	Snubber diode	800 V, 1.0A	Sanken / SARS05
D2	Fast recovery diode	300 V, 2 A	Sanken / SJPX-H3
D51	Schottky diode	150 V, 20 A	Sanken / FMEN-220B
L1	Inductor	18 mH, 0.9 A	
T1	Transformer	EER28	
R1	Resistor	470 k Ω , 1/4 W	
R2	Chip resistor	10 Ω , 1/4 W	
R3	Chip resistor	1.3 Ω , 1/2 W	
R4	Chip resistor	1.1 Ω , 1/2 W	
R5	Chip resistor	68 Ω , 1 W	
R6	Chip resistor	68 k Ω , 1/4 W	
R51	Chip resistor	2.2 k Ω , 1/4 W	
R52	Chip resistor	1.0 k Ω , 1/4 W	
R53	Chip resistor	10 k Ω , 1/4 W	
R54	Chip resistor	47 k Ω , 1/4 W	
R55	Chip resistor	3.3 k Ω , 1/4 W	
R56	Chip resistor	10 k Ω , 1/4 W	
U1	PWM off-line converter IC	700 V, 1.4 Ω	Sanken / STR6A124MV
U2	Shunt regulator	V _{REF} = 2.495 V	Texas Instruments / TL431
PC1	Optocoupler		Toshiba / TLP785
P1	Connector	250 V, 7 A	J.S.T.Mfg. / B2P3-VH
—	PCB		Sanken / PSA50156, Rev.2.0

* When multiple parts are listed, any one of them is used.

5.4 Pattern Layout Example

The design example uses only the parts listed in the circuit diagram and the bill of materials.
 PCB dimensions: 97.5 mm × 45 mm

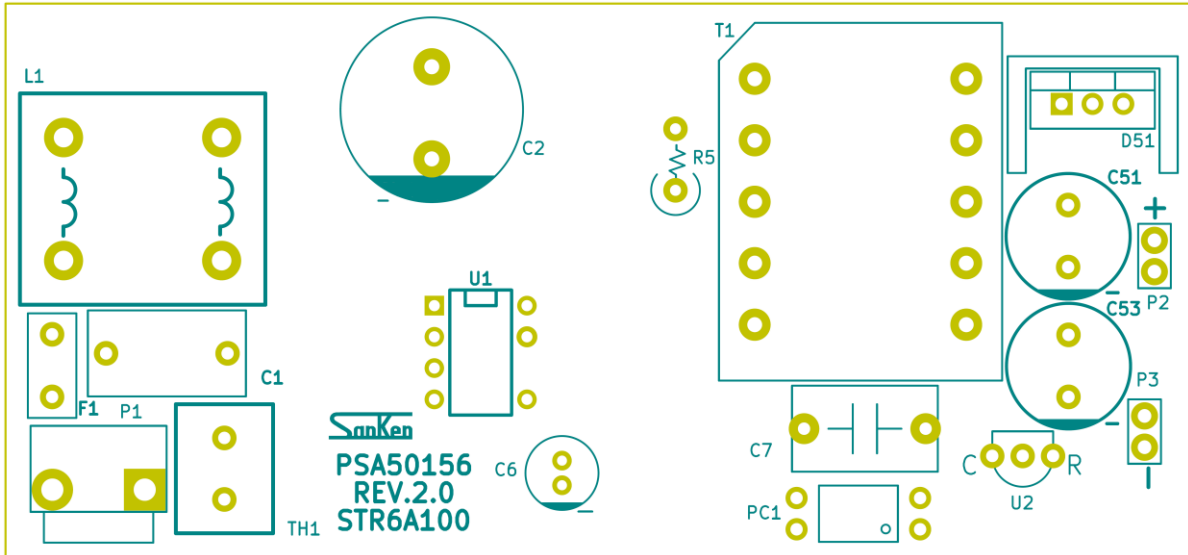

(a) Top View

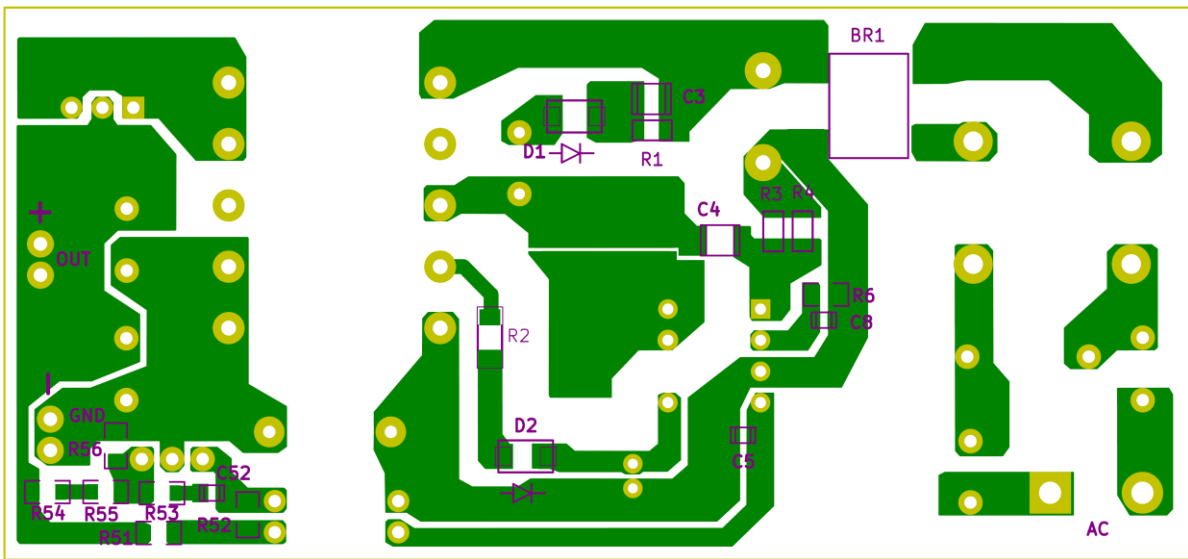

(b) Bottom View

Figure 5-2. Pattern Layout Example

6. Design Example: Basic Operations

The connector P1 is connected to an AC power supply. When an AC voltage is applied, the AC input voltage is full-wave rectified via the input filter and the bridge rectifier diode BR1. The rectified voltage is then smoothed to a DC voltage by the electrolytic capacitor C2. The input filter part includes the following components: C1 for a normal-mode noise filter; L1 for a common-mode noise filter; the power thermistor TH1 for an inrush current limiter.

When a voltage is applied to the D/ST pin of the power supply IC (U1: STR6A124MV), the internal startup circuit turns on. Consequently, a startup current flowing out of the VCC pin charges the electrolytic capacitor C6. When the VCC pin voltage increases to the IC operation start voltage, the IC control circuit starts to operate. Then, the internal power MOSFET starts its PWM switching operation. After the switching operation starts, a voltage is induced across the auxiliary winding D of the transformer T1. This induced voltage is rectified by D2 and C6 and is applied to the VCC pin. At this time, the internal startup circuit automatically turns off and the VCC pin power is supplied from the auxiliary winding D afterward. Note that the VCC pin voltage may be increased due to C6, which is charged by the surge voltage induced across the auxiliary winding D. For suppressing such voltage increase, R2 should be connected.

When the internal power MOSFET turns off, a ringing voltage is caused between the drain and source. For reducing such ringing voltage, the clamp snubber circuit (D1, C3, R1, and R5) should be connected across the winding P of the transformer T1. The SARS05, which is used for the diode D1, is a diode dedicated for snubber circuits and is contributory to not only ringing voltage reduction but also to better power supply efficiency by utilizing ringing energy effectively.

The current-sensing resistors, R3 and R4, connected to the S/OCP pin is for overcurrent detection. The light-receiving element of the optocoupler PC1 is connected to the FB/OLP pin, and a feedback signal is input for controlling the output voltage to be constant. The feedback current, I_{FB} , according to the load runs through PC1. Also, the capacitor C5 is connected to the FB/OLP pin, for high-frequency noise filtering and phase compensation. The resistor R6 and the noise filter capacitor C8 are connected to the BA pin. Connecting the resistor R6 allows the standby operating point to be adjustable by selecting a predetermined load factor.

In flyback converter design, the transformer T1 should consist of the primary and secondary sides whose polarities are connected oppositely. Energy is transferred from the primary side to the secondary side as follows. When the internal power MOSFET turns on, the input voltage, V_{INDC} , is applied to the winding P of the transformer T1. The transformer T1 then starts to store energy. As the secondary winding S has the reverse polarity, the secondary rectifier diode D51 does not become conductive at this time. Consequently, no power is transmitted from the primary side to the secondary side. When the internal power MOSFET turns off, the winding P generates a back EMF that conducts electricity to D51 and charges the electrolytic capacitors C51 and C53. Then, the energy stored in the transformer T1 is discharged to the secondary side. The light-emitting element of the optocoupler PC1 is configured as follows: the anode side is connected with the positive output (the connector P2) via the current-sensing resistor R51; the cathode side is connected with the shunt regulator U2. The resistor R52, connected across the anode and cathode of the light-emitting element of the optocoupler PC1, supplies the idling current flowing through PC1 to the shunt regulator U2. In order to enhance the constant voltage control, a high-precision resistor with an allowable tolerance of $\pm 1\%$ or less should be used for the resistors R54 to R56, which produce a voltage to be applied to the reference pin for the shunt regulator U2.

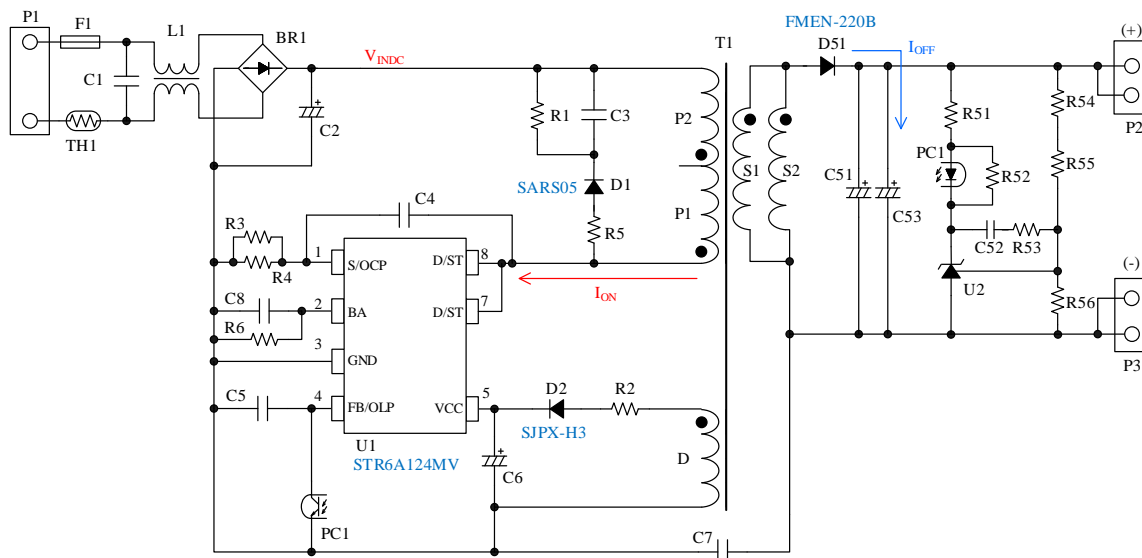

Figure 6-1. Circuit Diagram

7. Designing the Power Supply

7.1 Setting an Output Voltage

The equation below defines the relation between: the output voltage, V_{OUT} ; the reference voltage, $V_{FB(REF)}$, of the shunt regulator U2; and the resistors R54 to R56.

$$V_{OUT} = \frac{(R54 + R55 + R56) \times V_{FB(REF)}}{R56}. \quad (1)$$

Here are example setting values for $V_{FB(REF)}$ and the resistors R54 to R56 when $V_{OUT} = 15$ V:

$$\begin{aligned} V_{FB(REF)} &= 2.495 \text{ V} \\ R54 &= 47 \text{ k}\Omega \\ R55 &= 3.3 \text{ k}\Omega \\ R56 &= 10 \text{ k}\Omega \end{aligned}$$

7.2 Selecting the Bridge Rectifier Diode BR1

For the bridge rectifier diode BR1, select the one that has voltage and current ratings with sufficient margin to the upper limits of AC input voltage and current.

When the upper limit of an input voltage is 288 VAC, the voltage to be applied to BR1 is as follows: $V_p = 288 \text{ (VAC)} \times \sqrt{2} \approx 407 \text{ (VDC)}$. When a derating of $\geq 80\%$ is applied to the BR1 breakdown voltage, BR1 requires a breakdown voltage of ≥ 510 V.

The equation below defines the input current, I_{IN} :

$$I_{IN} = \frac{P_{OUT}}{V_{INAC(MIN)} \times \eta \times PF}. \quad (2)$$

Where:

P_{OUT} is the output power,
 $V_{INAC(MIN)}$ is the lower limit of the AC input voltage,
 η is the efficiency, and
 PF is the power factor.

From Equation (2), when $P_{OUT} = 27.8$ W, $V_{INAC(MIN)} = 85$ VAC, $\eta = 0.869$, $PF = 0.6$, hence $I_{IN} \approx 627$ mA. When a derating of $\geq 80\%$ is applied to the BR1 rated current, BR1 requires a rated current of ≥ 784 mA.

For the design example, we selected the bridge rectifier diode with a breakdown voltage of 1000 V and a rated current of 1.5 A, from the ones available in the market.

7.3 Selecting the Clamp Snubber Circuit (D1, C3, R1, R5)

For reducing surge voltages between the D/ST and S/OCP pins of the power supply circuit (U1: STR6A124MV), a clamp snubber circuit should be connected. As the maximum rated voltage of the internal power MOSFET is 700 V, the capacitor C3 and the discharging resistor R1 should be adjusted so that the power supply IC will have a surge voltage with a peak value of 650 V or less. The reference capacitance of C3 is 1000 pF to 3300 pF, whereas the reference resistance of R4 is 470 k Ω to 1 M Ω .

For D1 used in the design example, we selected the SARS05, our 800 V/1.0 A diode dedicated for snubber circuits. R5 is the current-limiting resistor for energy discharging and is recommended to use a resistor of about 68 Ω as we selected the SARS05 for the snubber diode.

7.4 Selecting the VCC Pin Rectifier Diode D2

For D2, select a fast recovery diode with a short recovery time because switching currents flow through it. Its rated voltage should have a sufficient margin to the voltage across the auxiliary winding D.

The design example employs the SJPX-H3, a 300 V/2 A fast recovery diode.

7.5 Selecting the Current-sensing Resistors (R3, R4)

When determining a constant of the current-sensing resistors, R3 and R4, the OCP threshold voltage, $V_{\text{OCP(H)}}$, of the power supply IC (U1: STR6A124MV) and resistance loss should be taken into account. Be sure to use a high-precision resistor with an allowable tolerance of $\pm 1\%$ or less for enhancing the constant voltage control.

When the combined resistance of R3 and R4 is 0.596Ω , the upper limit of $V_{\text{OCP(H)}}$ for the STR6A124MV is 0.933 V. Hence, the peak current that will flow through the current-sensing resistors, $I_{\text{RS_P}}$, is obtained by:

$$I_{\text{RS_P}} = \frac{0.933 \text{ (V)}}{0.596 \text{ (\Omega)}} = 1.565 \text{ (A)} .$$

When the power supply IC operates at switching duty cycle = 0.5, the effective current that will flow through the current-sensing resistors, $I_{\text{RS_RMS}}$, is as follows:

$$I_{\text{RS_RMS}} = 1.565 \text{ (A)} \times \sqrt{\frac{0.5}{3}} \approx 0.639 \text{ (A)} .$$

Thus, the resistance loss in the current-sensing resistors, P_{RS} , is determined by:

$$P_{\text{RS}} = I_{\text{RS_RMS}}^2 \times \left(\frac{R3 \times R4}{R3 + R4} \right) = 0.639^2 \times 0.596 \approx 0.243 \text{ (W)}$$

Based on the above calculation results, we selected R3 and R4 with a resistance of 1.3Ω (1/2 W) and 1.1Ω (1/2 W), respectively.

7.6 Selecting the Secondary Rectifier Diode D51

For D51, use a Schottky diode for minimizing the effect of the forward voltage, V_{F} , to output voltages. Moreover, select a Schottky diode having low leakage current characteristics with safety and power supply efficiency taken into account.

The rated current of D51 should have a sufficient margin to the rated load and rated peak current.

The rated voltage of D51, V_{RM} , should have sufficient margins as follows: to the winding turns ratio ($N_{\text{S}}/N_{\text{P}}$) of the transformer T1 defined by Equation (3); to the input voltage, V_{INDC} ; to a voltage determined by the output voltage, V_{OUT} .

$$V_{\text{RM}} \gg \left(\frac{N_{\text{S}}}{N_{\text{P}}} \times V_{\text{INDC}} \right) + V_{\text{OUT}} . \quad (3)$$

From Equation (3), when $V_{\text{INDC}} = 288 \text{ V} \times \sqrt{2}$, $V_{\text{OUT}} = 15 \text{ V}$, $N_{\text{S}}/N_{\text{P}} = 0.143$, hence $V_{\text{RM}} \gg 73 \text{ V}$. Based on this calculation result, the design example employs the FMEN-220B, a 150 V/20 A Schottky diode.

7.7 Transformer Specifications

Table 7-1 and Table 7-2 provide the design conditions for the transformer.

Table 7-1. Specifications: Input/Output

Winding	Symbol	Specifications	Remarks
Primary Winding	P	85 VAC to 288 VAC	
Secondary Winding	S	15 V, 1.85 A	Insulated from the winding P
Primary Auxiliary Winding	D	19 V	Non-insulated from the winding P; as a power supply for the VCC pin

Table 7-2. Specifications: Power Supply

Parameter	Specifications	Remarks
Maximum Load	27.8 W	
Input Voltage	288 VAC (max.)	
Circuit Efficiency	85%	
Average Input Current	0.302 A	108 VDC (estimated smoothed value)
Peak Switching Current	1.19 A	85 VAC (min.) at startup
Switching Frequency	65 kHz	
Maximum Duty Cycle	50.6%	

Table 7-3 lists the specifications of the transformer T1, which is designed from the conditions given in Table 7-1 and Table 7-2.

Table 7-3. Specifications: Transformer

Parameter	Specifications
Primary Inductance, L_P	710 μ H
Core Size	EER28 (see Table 7-4)
Bobbin	Vertical type, 10 pins (see Table 7-5)
AL-value	295 nH/N ² (center gap: 0.35 mm)
Winding Specifications	See Table 7-6.
Winding Structure	See Figure 7-1.

Table 7-4. Specifications: Core

Parameter	Specifications
Core Shape	EER28
Core Materials	Mn-Zn, PC40 materials or equiv.
Effective Core Cross-sectional Area, Ae	82.1 mm ²

Table 7-5. Specifications: Bobbin

Parameter	Specifications
Bobbin Shape	Vertical type
Number of Pins	10 pins
Creepage	Primary-to-secondary: 6.4 mm

Table 7-6. Specifications: Transformer Windings

Winding Name	Symbol	Turn (T)	Pin Numbers		Wire Diameter (mm)	Type
			Winding Start	Winding End		
Primary Winding 1	P1	32	3	2	φ 0.32, UEW1	Double-layer solenoidal winding
Secondary Winding 1	S1	7	10	6	φ 0.4 × 2, UEW1 parallell	Single-layer solenoidal winding
VCC Auxiliary Winding	D	9	4	5	φ 0.2, UEW1	Single-layer solenoidal winding (center-wound)
Secondary Winding 2	S2	7	9	7	Φ 0.4 × 2, UEW1 parallell	Single-layer solenoidal winding
Primary Winding 2	P2	17	2	1	φ 0.32, UEW1	Single-layer solenoidal winding

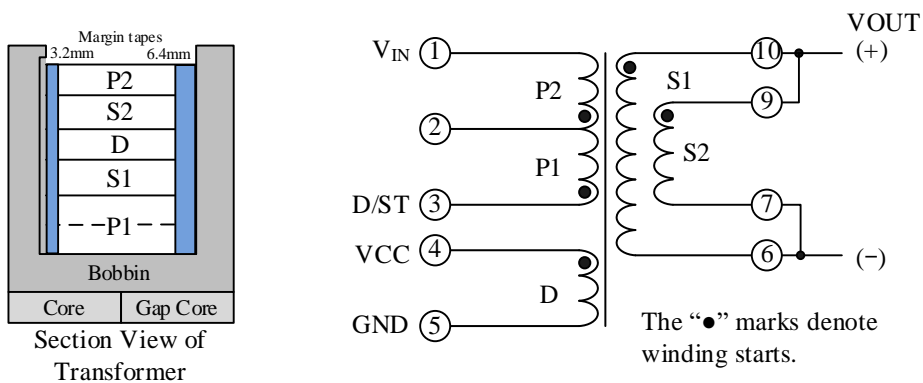

Figure 7-1. Structure of Windings

8. Performance Data

All the performance data contained in this document were measured at a room temperature, an AC line frequency of 50 Hz, and a load of 27.8 W (15 V, 1.85 A).

8.1 Efficiency

Figure 8-1 shows the characteristics of power supply efficiency vs. input voltage; Figure 8-2 shows the characteristics of power supply efficiency vs. output power.

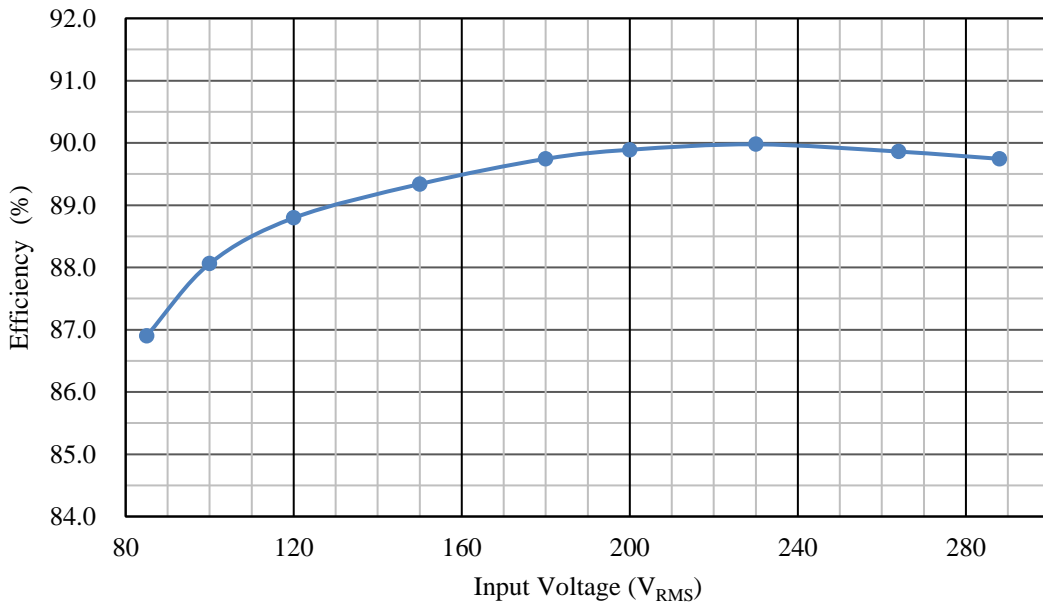

Figure 8-1. Efficiency vs. Input Voltage

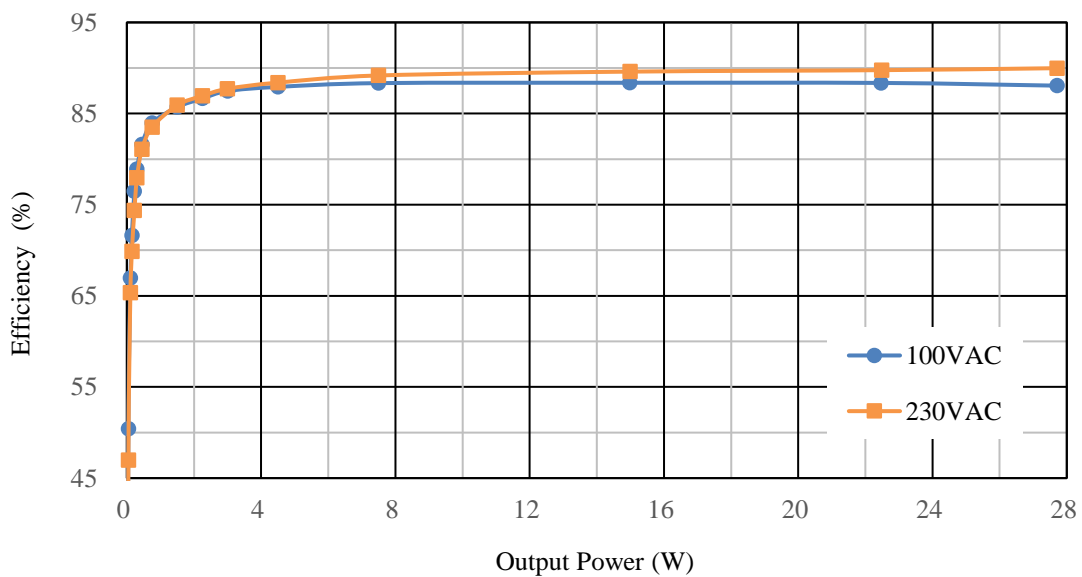

Figure 8-2. Efficiency vs. Output Power

8.2 Standby Power

Table 8-1. Input Power at No Load (R6 = 68 kΩ)

Input Voltage	Input Power
100 VAC	35.3 mW
230 VAC	41.0 mW

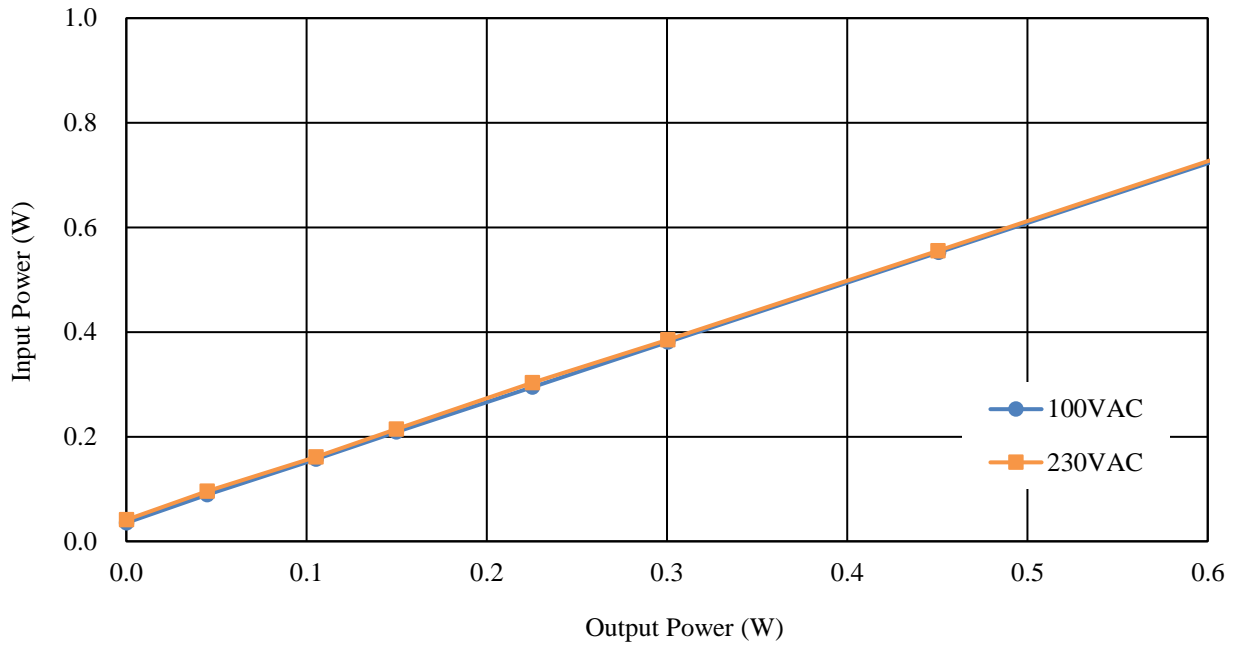

Figure 8-3. Input Power vs. Output Power

8.3 Line Regulation

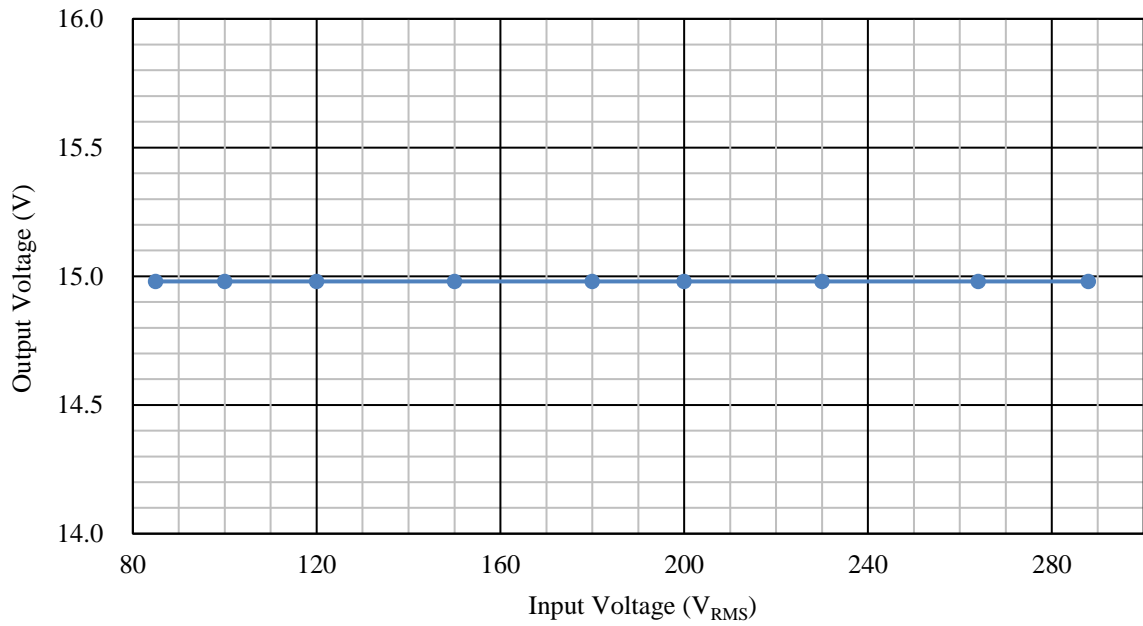

Figure 8-4. Output Voltage vs. Input Voltage

8.4 Load Regulation

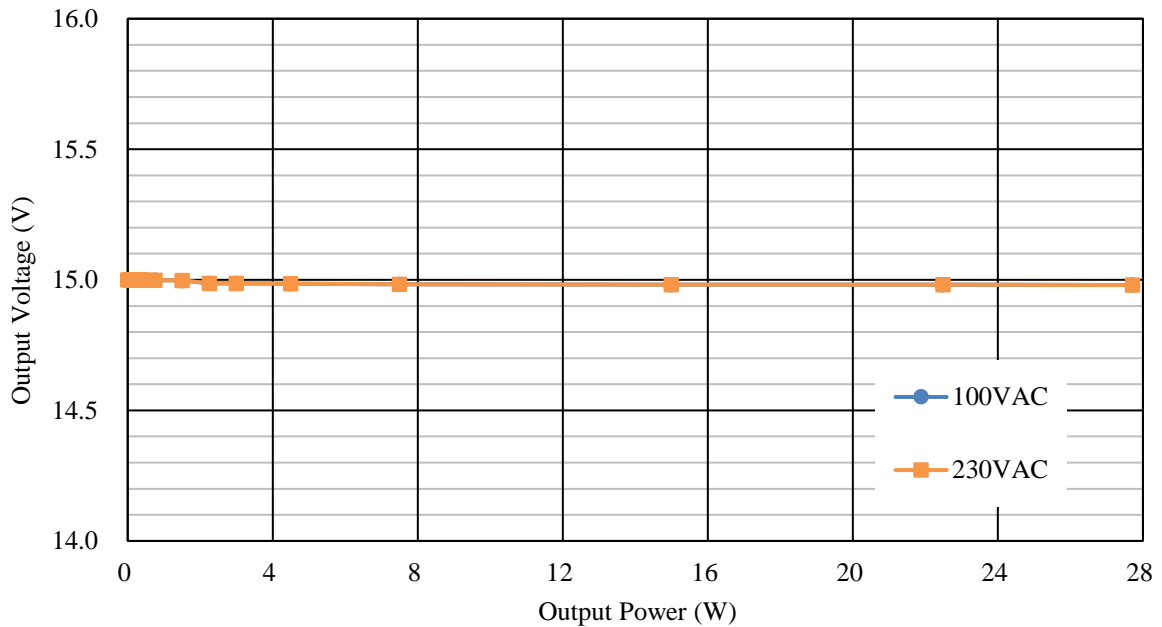

Figure 8-5. Output Voltage vs. Output Power

9. Operation Check

All the performance data contained in this document were measured at a room temperature and an AC line frequency of 50 Hz.

The maximum continuous load is 27.8 W (15 V, 1.85 A).

For more details on the power supply IC (STR6A124MV) such as electrical characteristics and operational descriptions, refer to the data sheet.

9.1 Startup Operation

9.1.1 Power Supply IC Switching Operation

When the soft start function is activated at power-on, the D/ST pin current, $I_{D/ST}$, of the power supply IC slowly increases. When the voltage across the current-sensing resistors, R3 and R4, reach the OCP threshold voltage of the power supply IC, the overcurrent protection (OCP) is activated to limit the output power.

Figure 9-1 shows the waveform of the D/ST pin voltage, $V_{D/ST}$. The pulsating part of the $V_{D/ST}$ waveform indicates a full-wave rectified input ripple component. The D/ST pin current, $I_{D/ST}$, is and remains limited by the OCP during the period until the output voltage becomes constant. When the output voltage becomes constant after the limitation, $I_{D/ST}$ decreases.

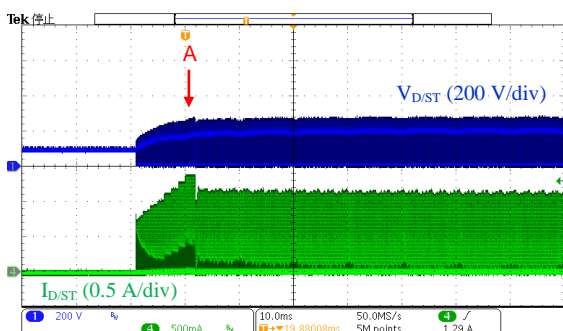

Figure 9-1. Operational Waveforms at Startup ($V_{IN} = 85 \text{ VAC}$, $I_O = 1.85 \text{ A}$)

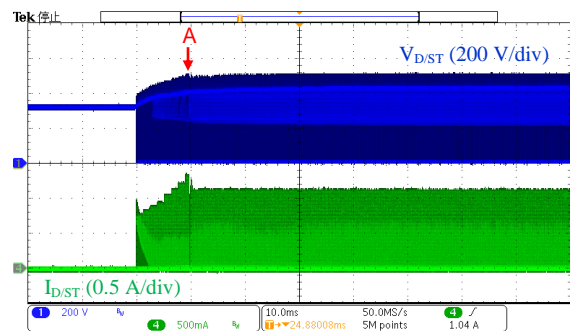

Figure 9-2. Operational Waveforms at Startup ($V_{IN} = 288 \text{ VAC}$, $I_O = 1.85 \text{ A}$)

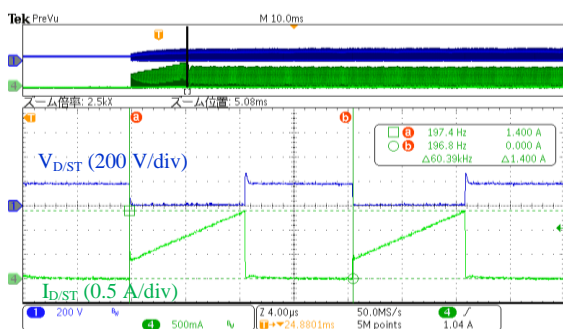

Figure 9-3. Operational Waveforms at Startup (Expanded Scale of A in Figure 9-1)

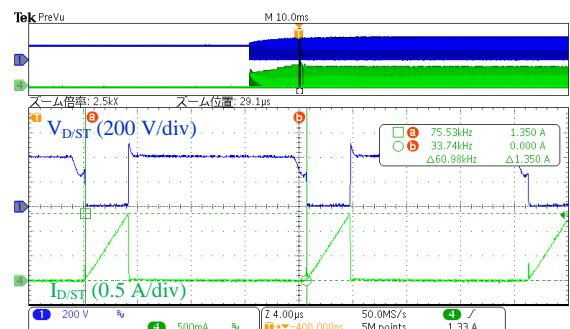

Figure 9-4. Operational Waveforms at Startup (Expanded Scale of A in Figure 9-2)

9.1.2 Output Voltage

When the soft start function is activated at power-on, the output voltage, V_{OUT} , gradually decreases. After V_{OUT} reaches its target voltage, V_{OUT} has no overshoot and shifts to the normal operation state within the power supply specifications.

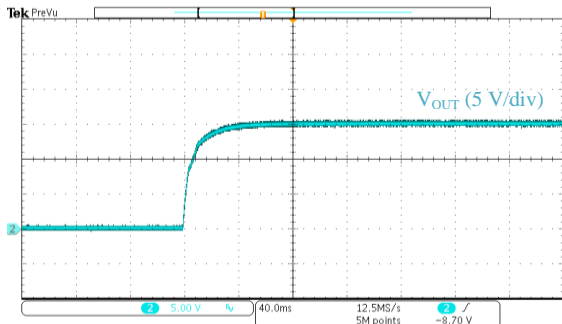

Figure 9-5. Output Voltage Waveform at Startup
($V_{IN} = 85 \text{ VAC}$, $I_O = 0 \text{ A}$)

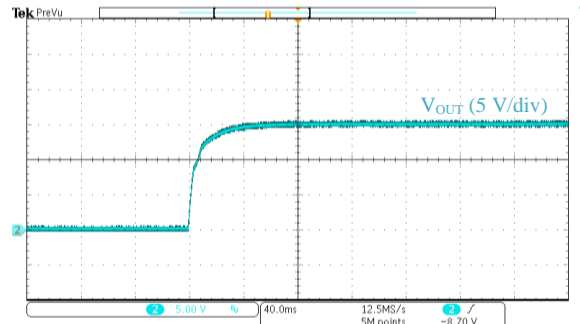

Figure 9-6. Output Voltage Waveform at Startup
($V_{IN} = 288 \text{ VAC}$, $I_O = 0 \text{ A}$)

9.1.3 VCC Pin Voltage

The auxiliary winding D of the transformer T1 is a voltage supply source for the VCC pin. Set the auxiliary winding D so that the VCC pin voltage, V_{CC} , will fall within the range of $V_{CC(BIAS)} < V_{CC} < V_{CC(OVP)}$. The reference voltage across the auxiliary winding D, V_D , is about 15 V to 20 V. In no-load operation, the power supply IC enters the burst oscillation operation as soon as its normal operation starts after startup. Thus, the VCC pin voltage decreases shortly after it increases once (see Figure 9-7, Figure 9-8). Note that the R2 value should be adjusted so that the VCC pin voltage will not become $V_{CC(BIAS)} = 10.5 \text{ V}$ (max.) or less, under all load ranges including the no-load operation.

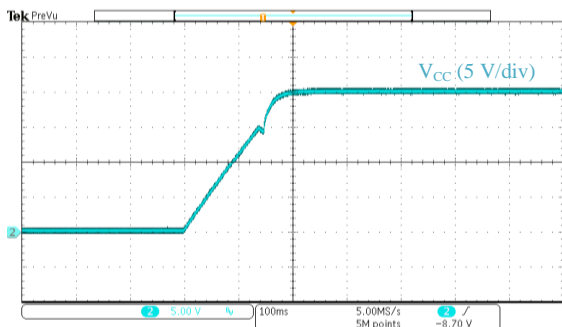

Figure 9-7. VCC Pin Voltage Waveform at Startup
($V_{IN} = 85 \text{ VAC}$, $I_O = 0 \text{ A}$)

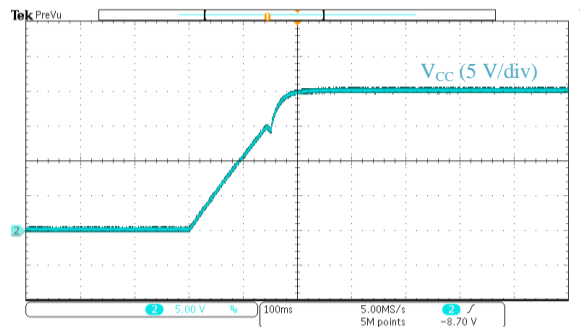

Figure 9-8. VCC Pin Voltage Waveform at Startup
($V_{IN} = 288 \text{ VAC}$, $I_O = 0 \text{ A}$)

9.1.4 D51 and D2 Applied Voltages

The STR6A124MV integrates the step drive control circuit that internally controls the gate drive of the power MOSFET in an optimal way, according to load conditions. This helps applications reduce surge voltages, including the one that occurs at a turn-on of the secondary rectifier diode D51, and the one applied to the VCC pin rectifier diode D2. Accordingly, the design example uses diodes with a breakdown voltage lower than conventional diodes. Moreover, the step drive control circuit allows applications to employ lower cost diodes, and to achieve higher circuit efficiency with lower VF characteristics.

Figure 9-9 and Figure 9-10 provide the waveforms of the voltages across D51 and D2 at startup, respectively.

In Figure 9-9, D51 yields the repetitive peak reverse voltage, V_{RM} , of about 74 V at maximum. This means that D51 (FMEN-220B) ensures a sufficient derating ($\leq 50\%$) to the maximum rated $V_{RM} = 150$ V.

In Figure 9-10, D2 yields the repetitive peak reverse voltage, V_{RM} , of about 111 V at maximum. This means that D2 (SJPX-H3) ensures a sufficient derating ($\leq 37\%$) to the maximum rated $V_{RM} = 300$ V.

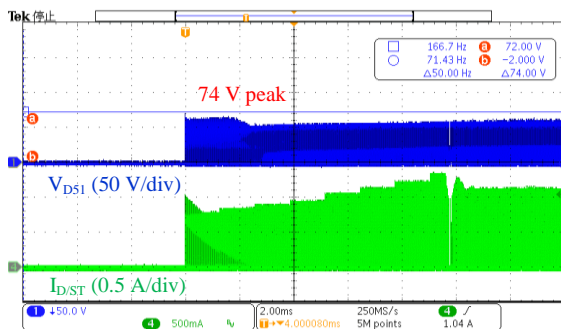

Figure 9-9. D51 Operational Waveforms at Startup
($V_{IN} = 288$ VAC, $I_O = 1.85$ A)

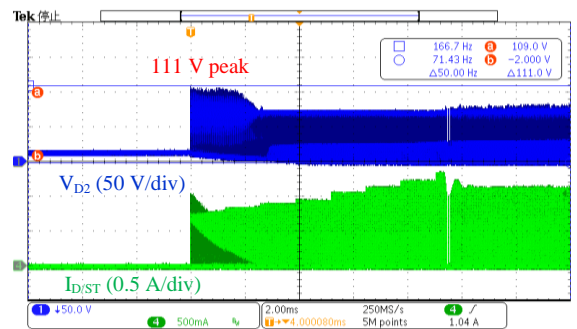

Figure 9-10. D2 Operational Waveforms at Startup
($V_{IN} = 288$ VAC, $I_O = 1.85$ A)

9.2 Power Supply IC Switching Operation

The STR6A124MV automatically shifts its operation modes according to loads and enhances efficiency in all load ranges. Therefore, the power supply IC monitors not only its normal operation but also the operations in all load ranges.

9.2.1 Normal Operation

Figure 9-11 to Figure 9-12 provide the waveforms in normal operation. These waveforms show that the frequency is about 61 kHz when $V_{IN} = 85$ VAC and is about 61 kHz when $V_{IN} = 288$ VAC. Each drain peak current setting has a margin to its overcurrent operating point.

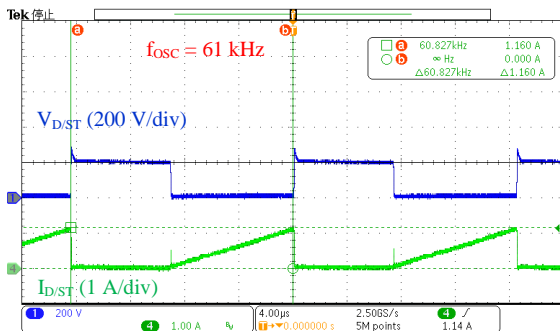

Figure 9-11. Operational Waveforms in Normal Operation ($V_{IN} = 85$ VAC, $I_O = 1.85$ A)

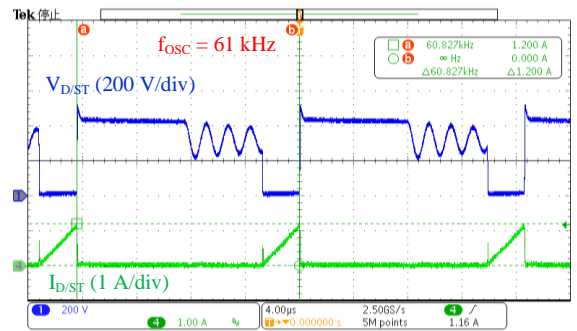

Figure 9-12. Operational Waveforms in Normal Operation ($V_{IN} = 288$ VAC, $I_O = 1.85$ A)

9.2.2 Light-load Operation (Green Mode, Burst Oscillation)

The lighter the load becomes, the lower the FB/OLP pin voltage decreases. When the FB/OLP pin voltage decreases to $V_{FB(FDS)} = 3.60\text{ V}$ (typ.) or less, the power supply IC shifts to the green mode and continues to reduce the frequency until the FB/OLP pin voltage reaches $V_{FB(FDE)} = 3.10\text{ V}$ (typ.).

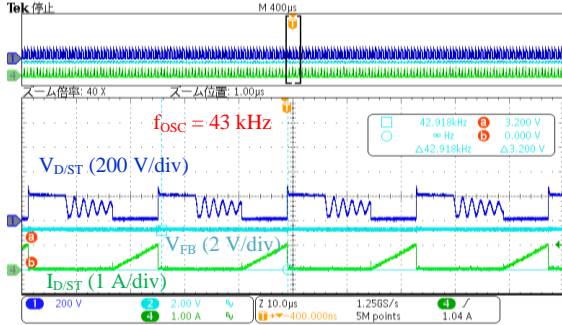

Figure 9-13. Operational Waveforms at Light Load ($V_{IN} = 85\text{ VAC}$, $I_O = 1\text{ A}$, $R_6 = 68\text{ k}\Omega$)

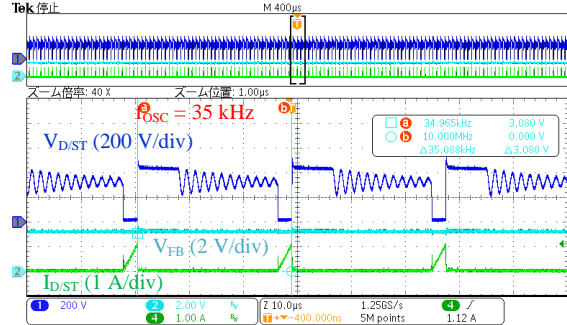

Figure 9-14. Operational Waveforms at Light Load ($V_{IN} = 288\text{ VAC}$, $I_O = 1\text{ A}$, $R_6 = 68\text{ k}\Omega$)

After the operational transition to the green mode, the FB/OLP pin voltage decreases. When the FB/OLP pin voltage reaches a preset standby operating point, the power supply IC shift into the burst oscillation operation. This standby operating point is adjustable by setting a value of the resistor R_6 connected to the BA pin. For the STR6A124MV, when $R_6 = 68\text{ k}\Omega$ with a load factor at the OCP operating point being set as 100%, a load factor at the standby operating point ranges from 6% to 11%.

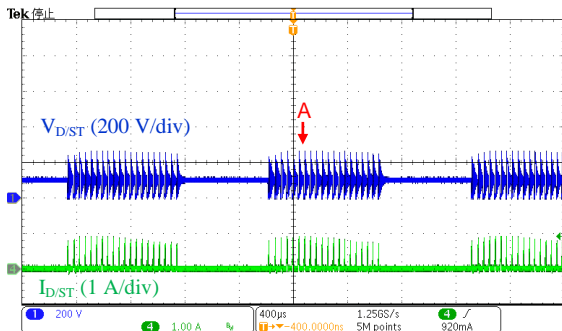

Figure 9-15. Operational Waveforms at Light Load ($V_{IN} = 85\text{ VAC}$, $I_O = 0.2\text{ A}$, $R_6 = 68\text{ k}\Omega$)

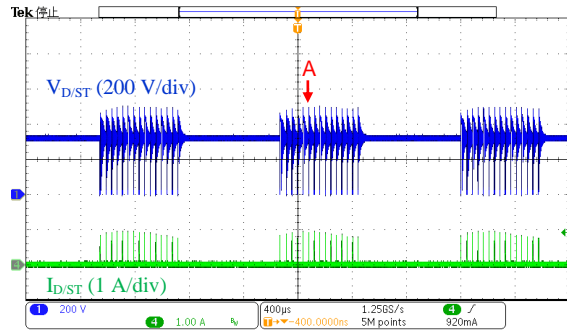

Figure 9-16. Operational Waveforms at Light Load ($V_{IN} = 288\text{ VAC}$, $I_O = 0.2\text{ A}$, $R_6 = 68\text{ k}\Omega$)

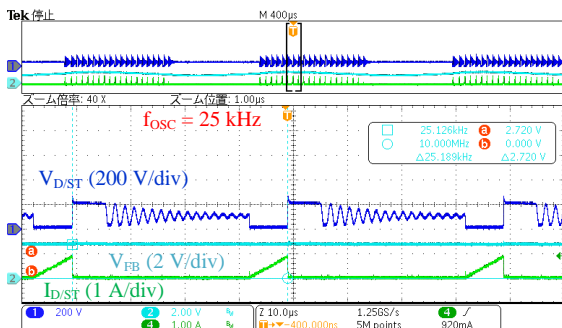

Figure 9-17. Operational Waveforms at Startup (Expanded Scale of A in Figure 9-15)

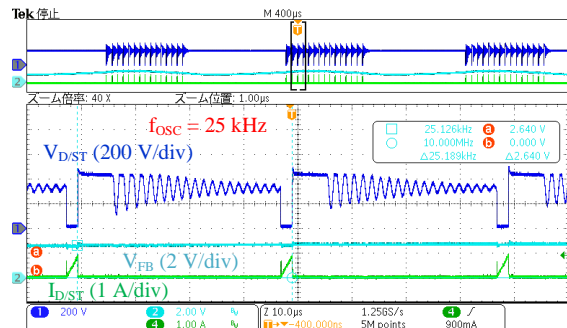

Figure 9-18. Operational Waveforms at Startup (Expanded Scale of A in Figure 9-16)

9.2.3 No-load Operation (Burst Oscillation)

The burst oscillation period changes according to loads. The burst oscillation period at no load, T_{STBOP} , of the design example is defined as follows: 67 ms when $V_{IN} = 85 \text{ VAC}$, and 75 ms when $V_{IN} = 288 \text{ VAC}$.

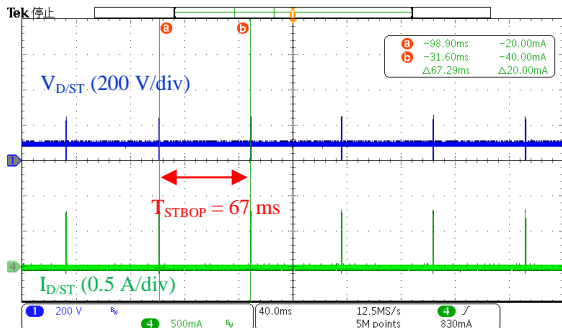

Figure 9-19. Operational Waveforms at No Load ($V_{IN} = 85 \text{ VAC}$, $I_O = 0 \text{ A}$, $R_6 = 68 \text{ k}\Omega$)

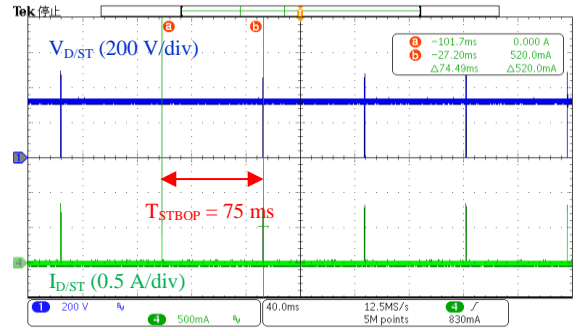

Figure 9-20. Operational Waveforms at No Load ($V_{IN} = 288 \text{ VAC}$, $I_O = 0 \text{ A}$, $R_6 = 68 \text{ k}\Omega$)

9.3 Output Ripple Voltage

The design example has output ripple voltages as follows: about 350 mV when $V_{IN} = 85 \text{ VAC}$, and about 260 mV when $V_{IN} = 288 \text{ VAC}$. Below are the measurement conditions:

- Added a filter to the output connector of the PCB (by connecting a 50 V, 1 μF electrolytic capacitor and a 50 V, 0.1 μF ceramic capacitor in parallel)
- Set a bandwidth of the oscilloscope to 20 MHz

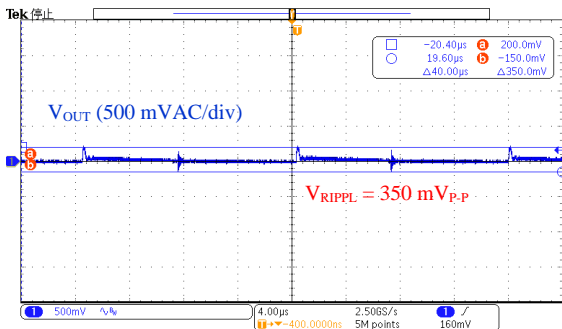

Figure 9-21. Output Ripple Voltage Waveform ($V_{IN} = 85 \text{ VAC}$, $I_O = 1.85 \text{ A}$)

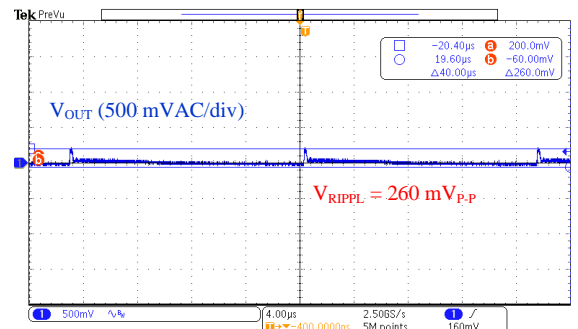

Figure 9-22. Output Ripple Voltage Waveform ($V_{IN} = 288 \text{ VAC}$, $I_O = 1.85 \text{ A}$)

9.4 OCP and OLP Operations

When the power supply IC reaches a certain load level, the overcurrent protection (OCP) limits the internal power MOSFET drain current, $I_{D/ST}$, to the drain current limit, I_{DLIM} . The equation below defines the relationship between I_{DLIM} and the current-sensing resistors R3 and R4:

$$I_{DLIM} = \frac{V_{OCP(H)} \times (R3 + R4)}{R3 \times R4} \tag{4}$$

Where:

$V_{OCP(H)}$ is the OCP threshold voltage when STR6A124MV = 36% duty cycle, and
 R3 and R4 are the resistances of the current-sensing resistors R3 and R4, respectively.

When the FB/OLP pin voltage exceeds the OLP threshold voltage, $V_{FB(OLP)} = 7.3 \text{ V}$ (typ.), and remains exceeded for the OLP delay time, $t_{OLP} = 75 \text{ ms}$ (typ.) or longer, the overload protection (OLP) is activated to stop switching operation. During the OLP operation, the intermittent oscillation operation repeated by the VCC pin voltage will reduce stresses on components such as the power MOSFET and the secondary rectifier diode. When the causes of the overload condition are eliminated, the power supply IC automatically returns to its normal operation.

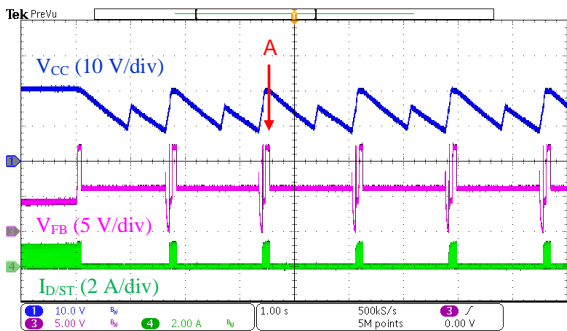

Figure 9-23. OCP and OLP Operational Waveforms ($V_{IN} = 85 \text{ VAC}$, $I_O > 1.85 \text{ A}$)

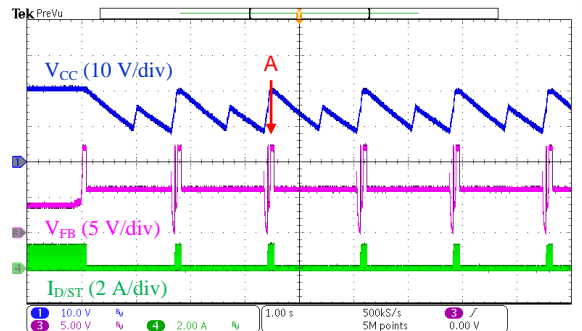

Figure 9-24. OCP and OLP Operational Waveforms ($V_{IN} = 288 \text{ VAC}$, $I_O > 1.85 \text{ A}$)

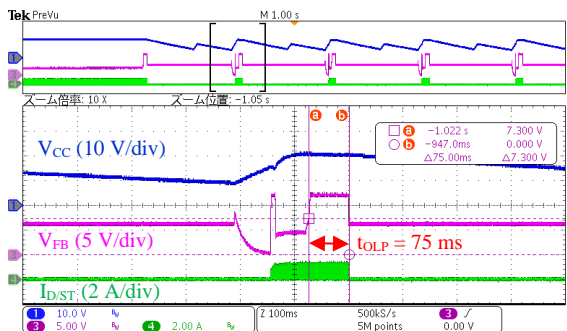

Figure 9-25. OCP and OLP Operational Waveforms (Expanded Scale of A in Figure 9-23)

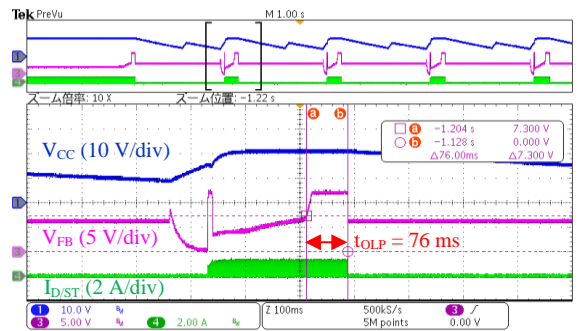

Figure 9-26. OCP and OLP Operational Waveforms (Expanded Scale of A in Figure 9-24)

9.5 OVP Operation

When the voltage between the VCC and S/GND pins of the power supply IC increases to the OVP threshold voltage, $V_{CC(OVP)} = 29.1 \text{ V}$ (typ.) or more, the overvoltage protection (OVP) is activated and power supply IC shifts to the OVP operation. In the OVP operation, an intermittent oscillation operation is repeated by the UVLO function of the VCC pin. When the causes of the overvoltage condition are eliminated, the power supply IC automatically returns to its normal operation.

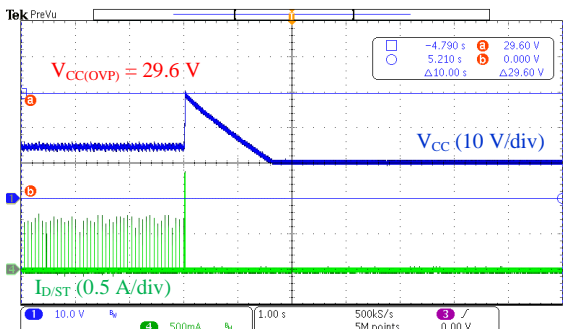

Figure 9-27. OVP Operational Waveforms ($V_{IN} = 85 \text{ VAC}$, $I_O = 0 \text{ A}$)

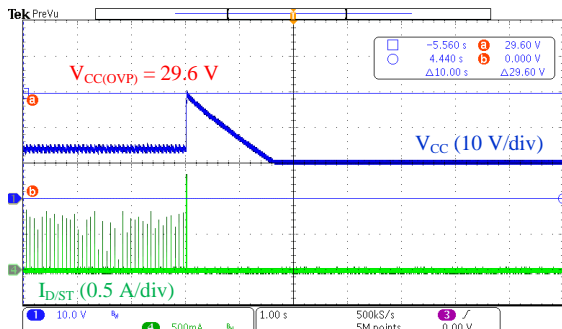

Figure 9-28. OVP Operational Waveforms ($V_{IN} = 288 \text{ VAC}$, $I_O = 0 \text{ A}$)

9.6 Case Temperature

Table 9-1 lists the individual component case temperatures at input voltage upper and lower limits, measured under the ambient temperatures 25 °C and 50 °C respectively.

Table 9-1. Input Voltage vs. Component Case Temperature ($I_O = 1.85 \text{ A}$)

Ambient Temperature (°C)	Input Voltage (VAC)	Case Temperatures in Normal Operation (°C)		
		Power Supply IC (U1)	Secondary Rectifier Diode (D51)	Transformer (T1)
25	85	66.5	71.9	57.6
	288	71.1	73.1	60.6
50*	85	91.5	96.9	82.6
	288	96.1	98.1	85.6

* Refers to case temperatures converted from the ones at an ambient temperature of 25 °C.

10. Conducted Emission Test

Figure 10-1 to Figure 10-4 show the measurement results of mains terminal disturbance voltage (EMI).

Measurement conditions: $I_O = 1.85 \text{ A}$, FG = open

Test mode: Average

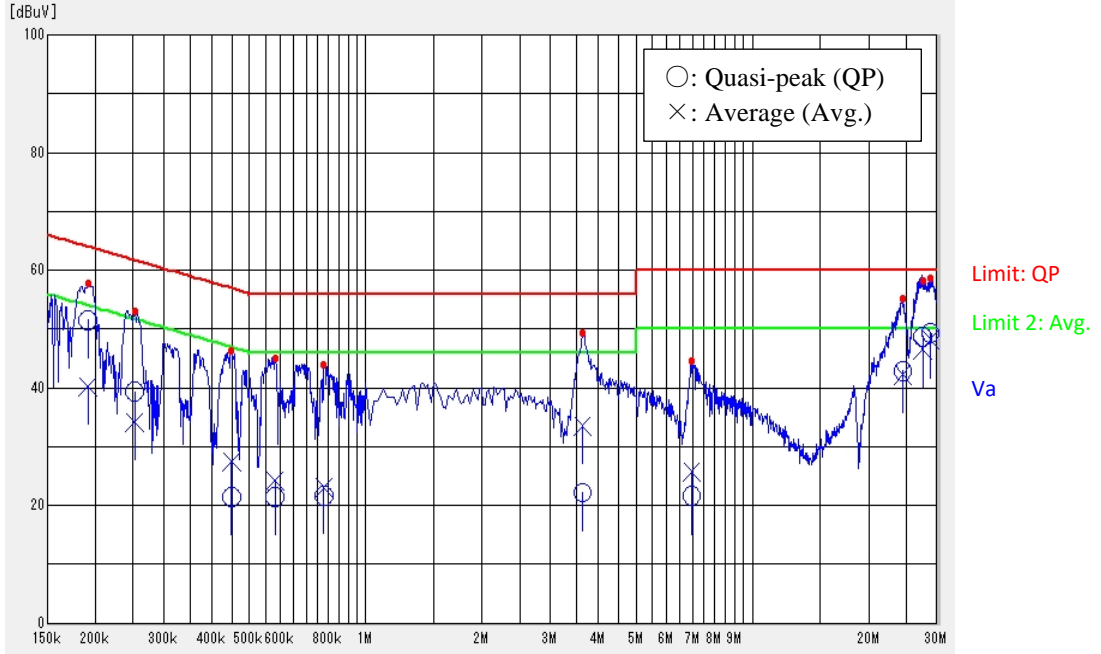

Figure 10-1. EMI Measurement Result (Live, $V_{IN} = 100 \text{ VAC}$)

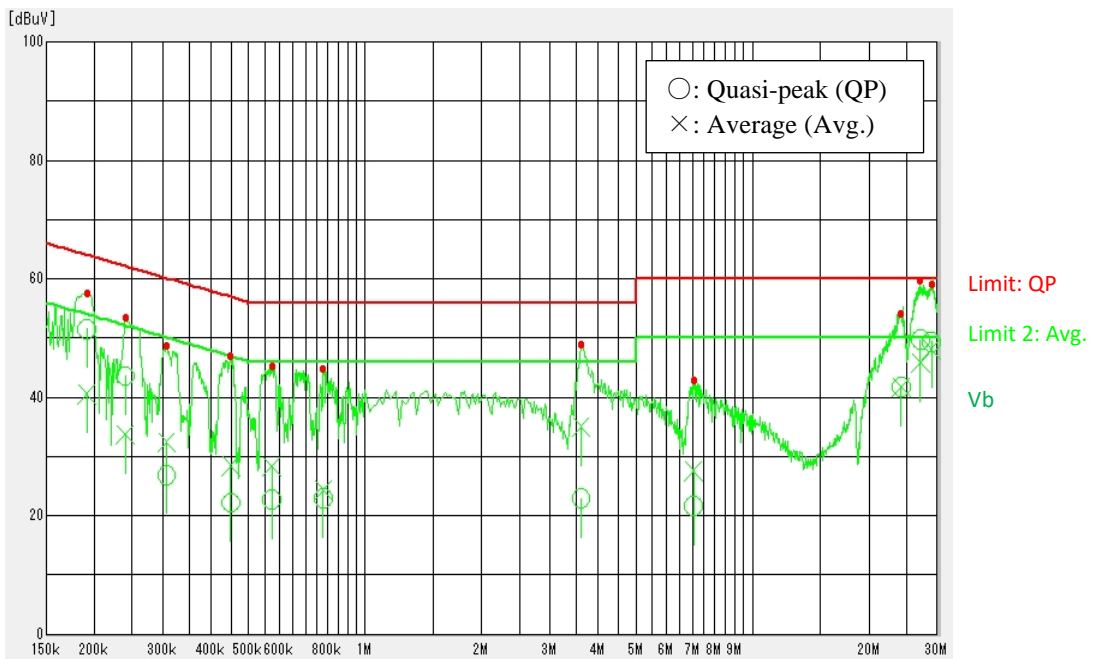

Figure 10-2. EMI Measurement Result (Neutral, $V_{IN} = 100 \text{ VAC}$)

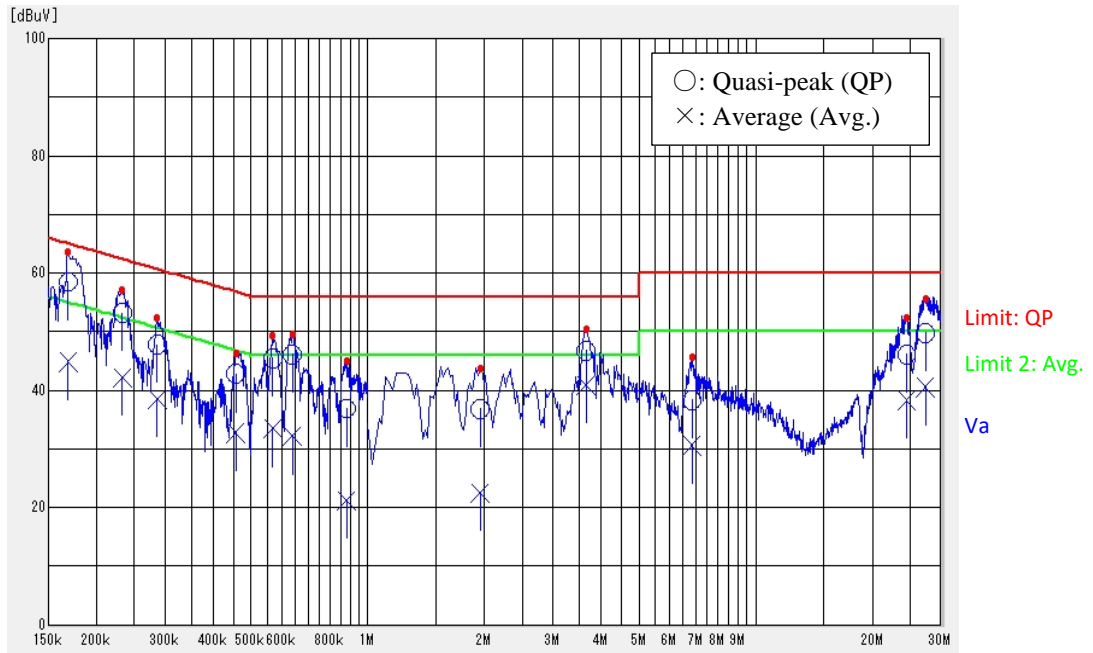

Figure 10-3. EMI Measurement Result (Live, $V_{IN} = 230$ VAC)

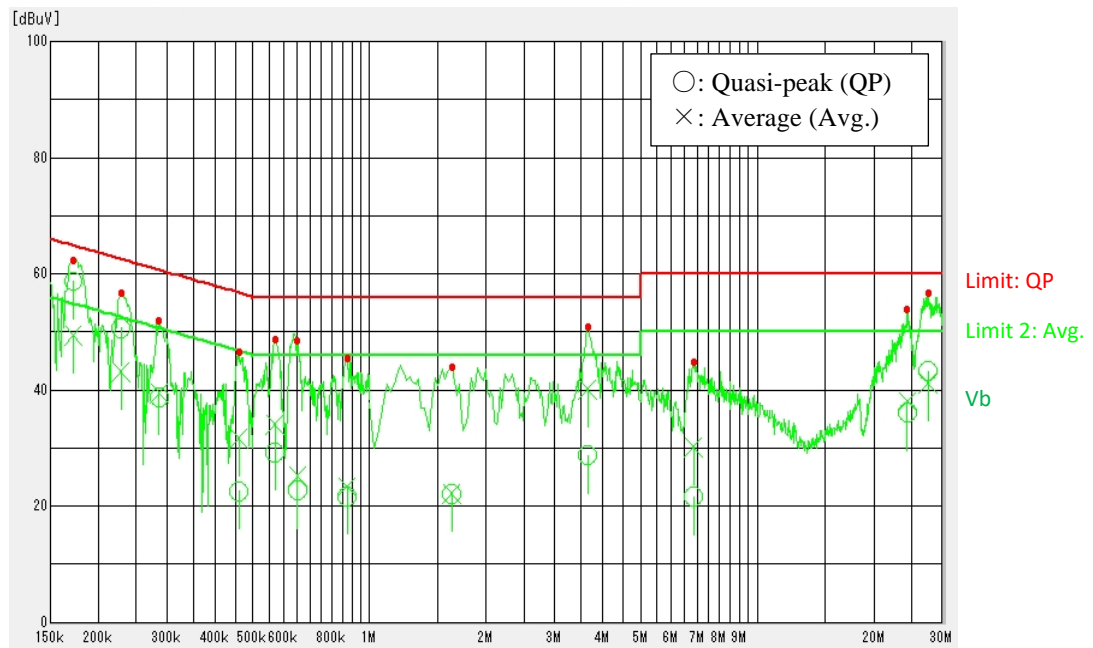

Figure 10-4. EMI Measurement Result (Neutral, $V_{IN} = 230$ VAC)

Important Notes

- All data, illustrations, graphs, tables and any other information included in this document (the “Information”) as to Sanken’s products listed herein (the “Sanken Products”) are current as of the date this document is issued. The Information is subject to any change without notice due to improvement of the Sanken Products, etc. Please make sure to confirm with a Sanken sales representative that the contents set forth in this document reflect the latest revisions before use.
- The Sanken Products are intended for use as components of general purpose electronic equipment or apparatus (such as home appliances, office equipment, telecommunication equipment, measuring equipment, etc.). Prior to use of the Sanken Products, please put your signature, or affix your name and seal, on the specification documents of the Sanken Products and return them to Sanken. When considering use of the Sanken Products for any applications that require higher reliability (such as transportation equipment and its control systems, traffic signal control systems or equipment, disaster/crime alarm systems, various safety devices, etc.), you must contact a Sanken sales representative to discuss the suitability of such use and put your signature, or affix your name and seal, on the specification documents of the Sanken Products and return them to Sanken, prior to the use of the Sanken Products. The Sanken Products are not intended for use in any applications that require extremely high reliability such as: aerospace equipment; nuclear power control systems; and medical equipment or systems, whose failure or malfunction may result in death or serious injury to people, i.e., medical devices in Class III or a higher class as defined by relevant laws of Japan (collectively, the “Specific Applications”). Sanken assumes no liability or responsibility whatsoever for any and all damages and losses that may be suffered by you, users or any third party, resulting from the use of the Sanken Products in the Specific Applications or in manner not in compliance with the instructions set forth herein.
- In the event of using the Sanken Products by either (i) combining other products or materials or both therewith or (ii) physically, chemically or otherwise processing or treating or both the same, you must duly consider all possible risks that may result from all such uses in advance and proceed therewith at your own responsibility.
- Although Sanken is making efforts to enhance the quality and reliability of its products, it is impossible to completely avoid the occurrence of any failure or defect or both in semiconductor products at a certain rate. You must take, at your own responsibility, preventative measures including using a sufficient safety design and confirming safety of any equipment or systems in/for which the Sanken Products are used, upon due consideration of a failure occurrence rate and derating, etc., in order not to cause any human injury or death, fire accident or social harm which may result from any failure or malfunction of the Sanken Products. Please refer to the relevant specification documents and Sanken’s official website in relation to derating.
- No anti-radioactive ray design has been adopted for the Sanken Products.
- The circuit constant, operation examples, circuit examples, pattern layout examples, design examples, recommended examples, all information and evaluation results based thereon, etc., described in this document are presented for the sole purpose of reference of use of the Sanken Products.
- Sanken assumes no responsibility whatsoever for any and all damages and losses that may be suffered by you, users or any third party, or any possible infringement of any and all property rights including intellectual property rights and any other rights of you, users or any third party, resulting from the Information.
- No information in this document can be transcribed or copied or both without Sanken’s prior written consent.
- Regarding the Information, no license, express, implied or otherwise, is granted hereby under any intellectual property rights and any other rights of Sanken.
- Unless otherwise agreed in writing between Sanken and you, Sanken makes no warranty of any kind, whether express or implied, including, without limitation, any warranty (i) as to the quality or performance of the Sanken Products (such as implied warranty of merchantability, and implied warranty of fitness for a particular purpose or special environment), (ii) that any Sanken Product is delivered free of claims of third parties by way of infringement or the like, (iii) that may arise from course of performance, course of dealing or usage of trade, and (iv) as to the Information (including its accuracy, usefulness, and reliability).
- In the event of using the Sanken Products, you must use the same after carefully examining all applicable environmental laws and regulations that regulate the inclusion or use or both of any particular controlled substances, including, but not limited to, the EU RoHS Directive, so as to be in strict compliance with such applicable laws and regulations.
- You must not use the Sanken Products or the Information for the purpose of any military applications or use, including but not limited to the development of weapons of mass destruction. In the event of exporting the Sanken Products or the Information, or providing them for non-residents, you must comply with all applicable export control laws and regulations in each country including the U.S. Export Administration Regulations (EAR) and the Foreign Exchange and Foreign Trade Act of Japan, and follow the procedures required by such applicable laws and regulations.
- Sanken assumes no responsibility for any troubles, which may occur during the transportation of the Sanken Products including the falling thereof, out of Sanken’s distribution network.
- Although Sanken has prepared this document with its due care to pursue the accuracy thereof, Sanken does not warrant that it is error free and Sanken assumes no liability whatsoever for any and all damages and losses which may be suffered by you resulting from any possible errors or omissions in connection with the Information.
- Please refer to our official website in relation to general instructions and directions for using the Sanken Products, and refer to the relevant specification documents in relation to particular precautions when using the Sanken Products.
- All rights and title in and to any specific trademark or tradename belong to Sanken and such original right holder(s).

DSGN-CEZ-16003